

E-scooter

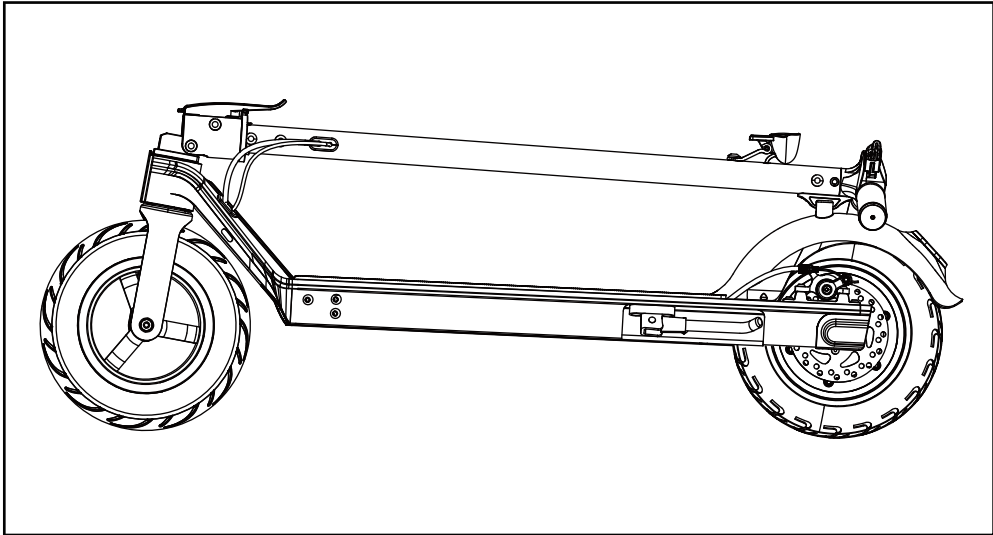

E-scooter

(Picture above is for illustration only)

The Package contents includes the following parts

Please Contact RND authorized dealers or RND after-service center if there is any missing spare parts

| | |
|-------------------------------|--------------|
| Scooter Frame | Hand Bar Kit |
| Installation tool & Screw | Charger |
| User manual (English version) | |

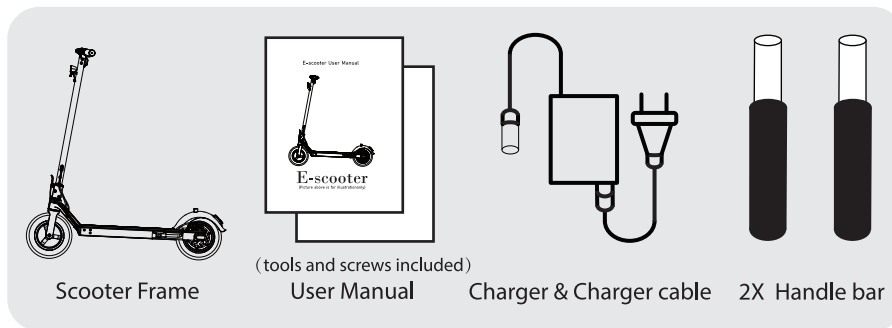

Product Structure

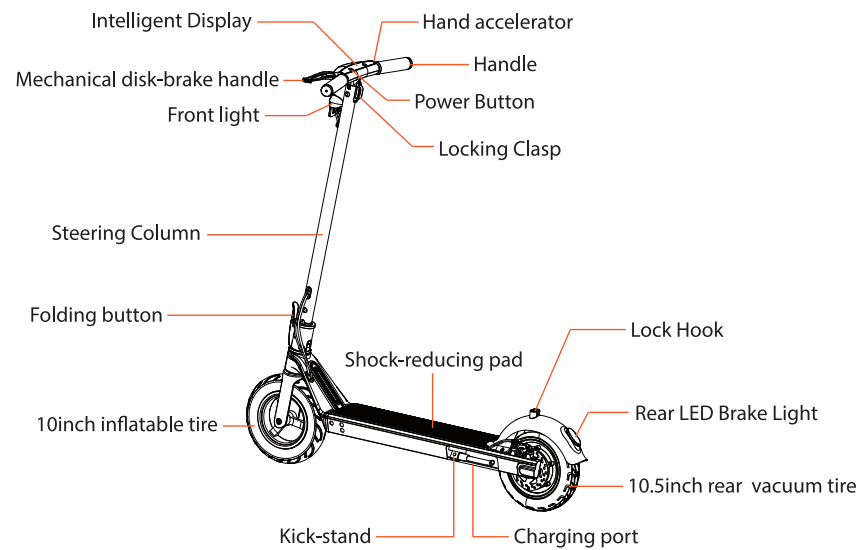

Product Maintenance

⚠ Storage

Avoid placing the scooter in long periods of time in direct sunlight, rain or environments of heavy humidity

During long idle periods, perform battery check and battery charge to ensure batteries fully charge and avoid the battery over-discharge

Kick stand is designed for structural support, Avoid standing on F16 while kick stand is down, this action can cause the kick stand to crack and break

⚠ Cleaning

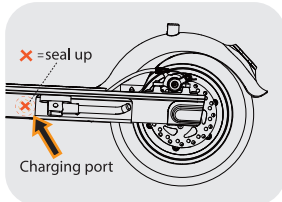

Before Washing the scooter, Turn off the power of the scooter, Cover DC power receptacle with receptacle cover to prevent water flowing into the power receptacle

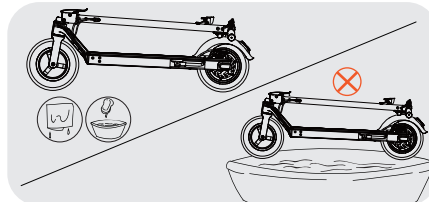

Using cloths and clean or soapy water to wipe the scooter's exterior, Do not immerse the scooter in water at anytime

⚠ Maintenance

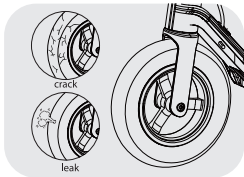

If front tire appears crack and leaking, replace the front tire immediately

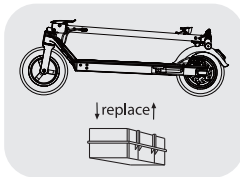

When experience significant reduction in range, replace battery immediately, please bring used battery to appropriate recycling facility

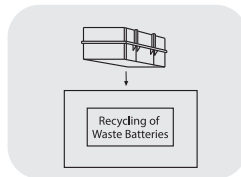

Waste batteries cannot be discarded casually to avoid polluting the environment

⚠ Disk-brake distance adjustment

When the braking distance exceeds 3.5M, The tightness of brake line can be adjusted Manually , Tighten the brake line and make sure the disk brake works perfect

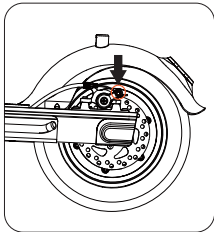

1. Unscrew the fixing screw on the brake shaft

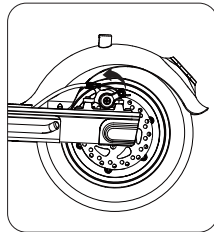

2. Adjust the suitable length of the brake line

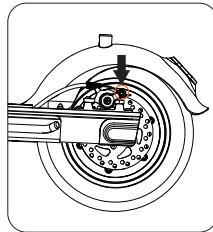

3. Screw the fixing screw on the brake shaft

Assembly instructions

Check the package contents carefully and make sure all parts are in good condition, then take the scooter out of the box in folding status with kickstand down

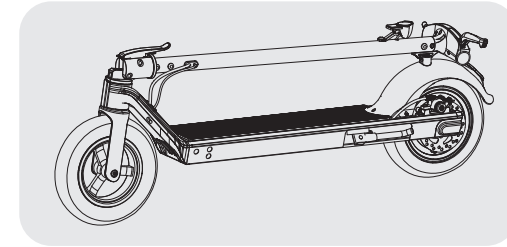

Rotate the handle in a clockwise direction till it is fixed

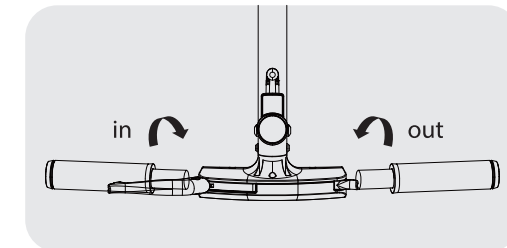

Inflation

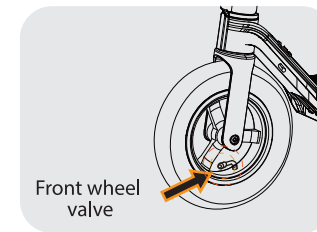

Front tire pressure suggestion
(2.5bar / 250 KPA / 36PSI)

Integrated intelligent dashboard

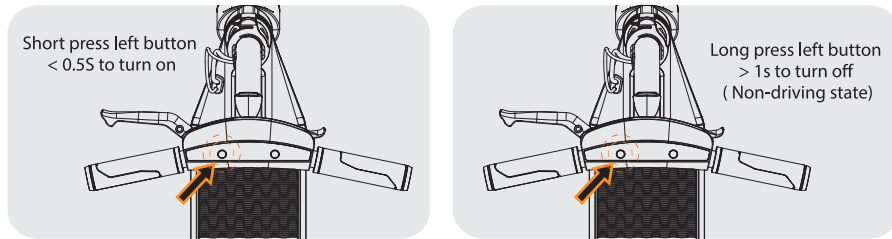

Shut-down automatically after 10mins no using

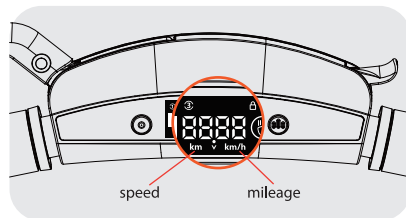

Total mileage displayed in non-driving state with unit KM
Current speed displayed in driving state with unit KM/H

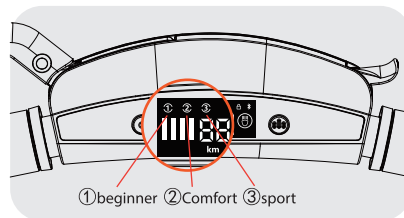

double click the left button to switch speed mode

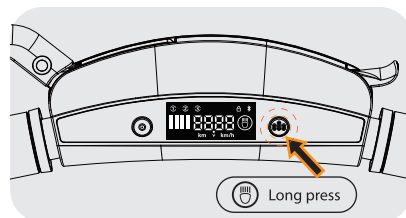

Long press right button to turn on and turn off the front light

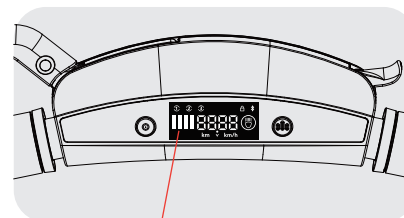

Battery display with 4 Bar

Product specification

| Serial Number | Specification | Details |
|---------------|---------------|---|
| 1 | Model | F16 |
| 2 | Net Weight | 12.5±1 KG |
| 3 | Max load | 100KG |
| 4 | Max speed | 30KM/h |
| 5 | Product size | 1070x410x1179MM |
| 6 | Battery | Lithium-ion battery (36V/7.8Ah) |
| 7 | Charging time | 5~7hours |
| 8 | Tire type | 10inch front inflatable tire 10.5inch rear vacuum tire |

Battery specification

| Serial Number | Specification | Details | Note |
|---------------|----------------------|-----------------------|---|
| 1 | Battery type | Lithium-ion battery | Battery operating temp cannot exceed temp specified by this table Charge time varies by environment and battery capacity changes |
| 2 | Charging time | 5-7 hours(36v 7.8Ah) | |
| 3 | Battery model | 36V/7.8Ah(280.8Wh) | |
| 4 | Rated output voltage | 42V | |
| 5 | Operating temp | Charge: 0~45°C | |
| | | Discharge: -20~60°C | |
| 6 | Storage temp | -20~45°C | |

Charging safety tips ⚠

- First time charging requires 5-7 hours
- To Maximize battery life, please charge the battery at least every other month or two days after the last riding
- Batteries must be charged periodically to maintain its charge, neglecting to do so may cause the battery over-discharge which can lead to severe damage to the batteries
- User charger provided by the scooter vendor
- Charging must be conducted in a dry, well ventilated area, make certain power receptacle is dry, do not touch power receptacle with wet hands

Over Discharge protection

F16 has the internal over-discharge protection, when the scooter is on shut down state /battery is low, the control system will power off to protect the battery bank, in order to bypass over-discharge protection, the scooter need to be charged to wake up, if the scooter does not wake up 30 minutes charging, contact vendor authorized dealers or vendor post sales service department

Warning

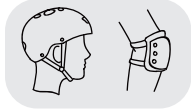

Pls make sure ride with helmet and protective gears

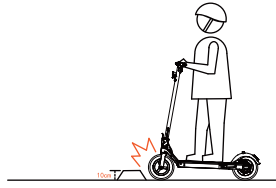

Pay attention to avoid obstacles on the road

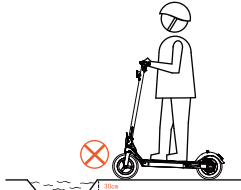

The wading depth cannot exceed 20 mm

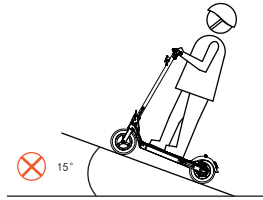

Do not exceed 15-degree slopes while riding

Do not do

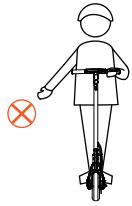

Do not ride only by one hand

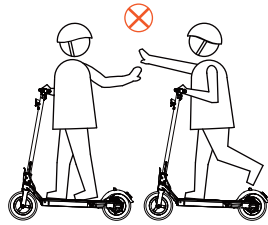

Do not play with each other while riding

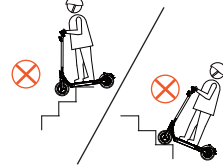

Do not ride up and down stairs



Do not immerse scooter in water

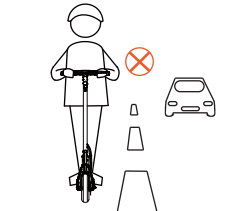

Do not ride on the vehicle road

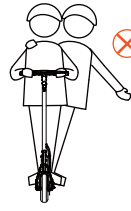

Do not ride more than one person at any time



Do not ride on the Slippery road and Ice-snow Roads

Folding & Unfolding instructions

Step 1 : Unclasp the locking clasp

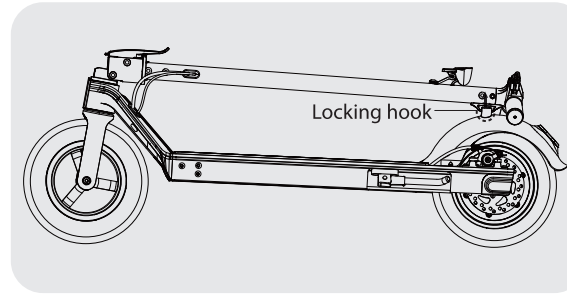

Note:

Slide slip the locking clasp out of the hook

Step 2: Turning to a certain angle to avoid hitting the protective cover when lift steering column up, then push the steering column a little to lock the folding button into final position.

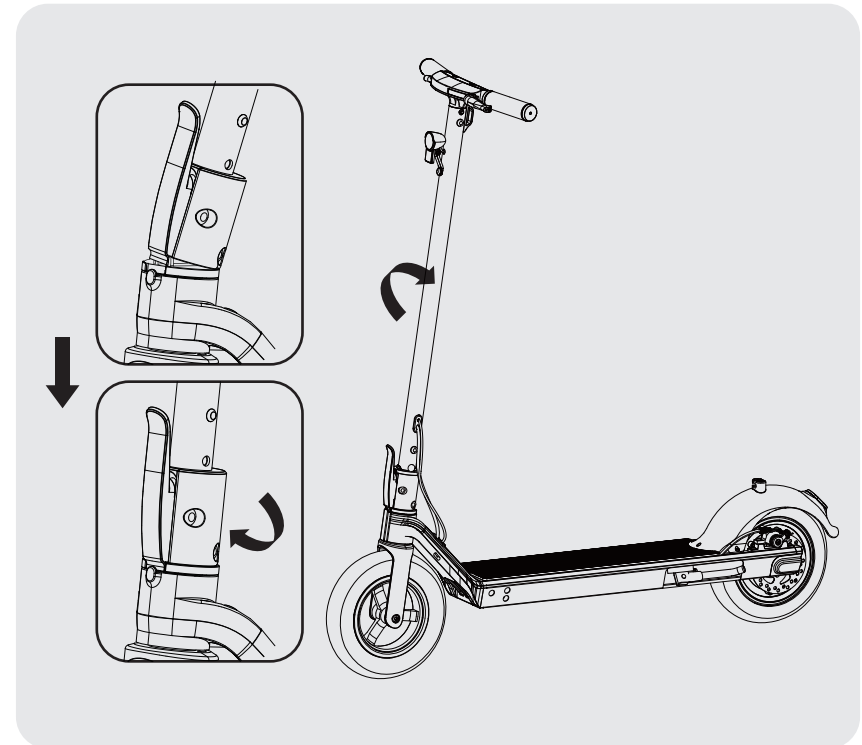

Folding the scooter

Step 1: Turn the steering column at a certain degree until the folding button is completely away from the protective cover, then press down the folding button

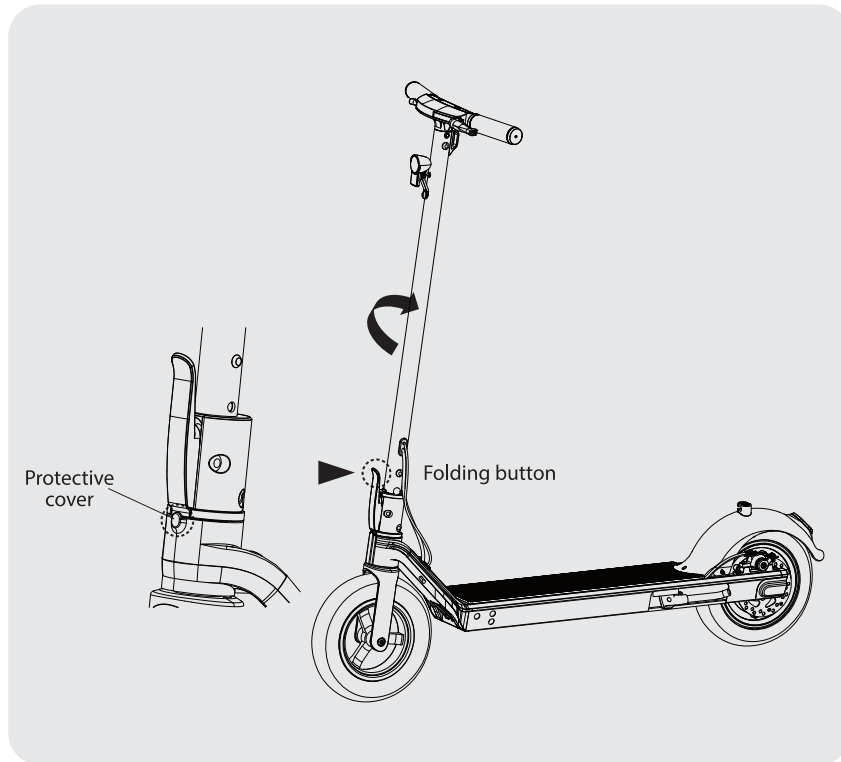

Step 2 : Folding down the steering column, Align the locking clasp with the side of the locking hook, then buckle into the locking hook in parallel

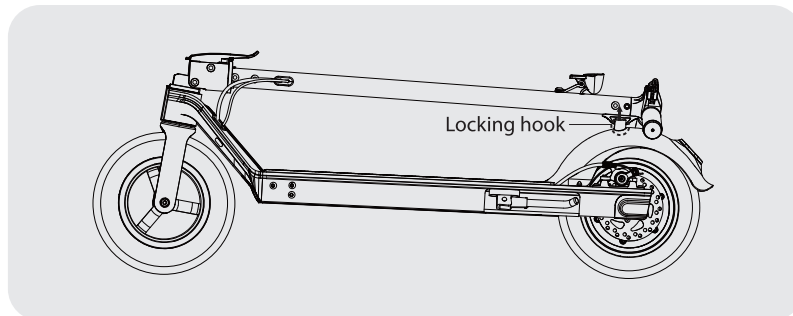

Checking list before Operation ⚠

The e-scooter involves a few mechanical and electric setting ,Before riding , Inspect each component of the vehicle to ensure normal operation, Below are the points to pay much more attention to:

- (1) Be sure the Utility/Locking hook locked in place
- (2) Check and make sure the handle bar are not in loosen
- (3) Check and make sure the tire is properly inflated
- (4) Check and make sure the battery is fully charged
- (5) Be sure to read the user manual before riding at your first time

How to ride the e-scooter

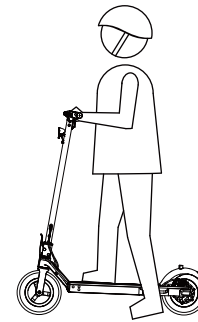

1 Hold the handle bars with your hands, and put your right foot on the pedal, then slide your left foot and use the acceleration trigger to push the scooter

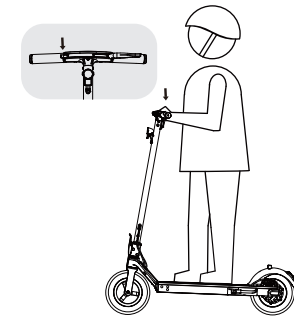

2 The harder you squeeze the acceleration trigger, the faster you will speed up

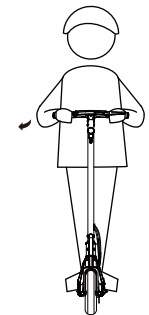

3 Use the handbar to turn in the direction you wish

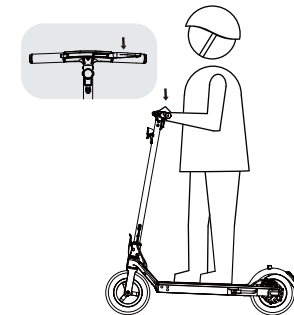

4 To slow down the scooter, disengage the accelerator and squeeze the brake handle to engage the e-brake and disc brake